

# BIO SCULPTURE



## PRODUCT CATALOGUE

BIO GEL evō BI-OLYGEL ETHOS GEMINI SPA

HEALTHY | ETHICAL | PROFESSIONAL

Our purpose is to provide quality products and professional training, empowering nail technicians to offer healthy and fashionable nail care systems, guided by an ethical business approach.

















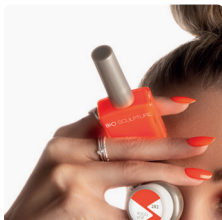







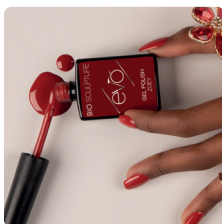

BIOGEL evō BI-OLYGEL ETHOS GEMINI SPA

Tel: (+27)51 943 0377 | Email: [info@biosculpture.com](mailto:info@biosculpture.com) | URL: [www.biosculpture.com](http://www.biosculpture.com)  
Physical Address: No. 8 Industria Road, Clocolan, Free State 9735, South Africa  
Facebook: [@BioSculptureOfficial](https://www.facebook.com/BioSculptureOfficial) | Instagram: [@bio\\_sculpture\\_official](https://www.instagram.com/bio_sculpture_official) | Youtube: Bio Sculpture

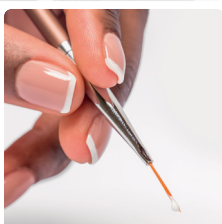

# TABLE OF CONTENTS

<p><b>BIOGEL .04</b></p> 	<p><b>EVO .06</b></p> 	<p><b>BI-OLYGEL .08</b></p> 	<p><b>ETHOS .09</b></p> 		
<p><b>NAIL ART .12</b></p> 	<p><b>CARMEN .15</b></p> 	<p><b>GEMINI .11</b></p> 			
<p><b>SUMMER HEEL .19</b></p> 			<p><b>SPA .16</b></p> 	<p><b>SOLVENTS .18</b></p> 	<p><b>MANUALS .25</b></p> 
<p><b>TIPS &amp; ADHESIVES .26</b></p> 	<p><b>KITS .20</b></p> 	<p><b>UTENSILS .22</b></p> 		<p><b>BRUSHES .30</b></p> 	<p><b>BUFFS &amp; FILES .32</b></p> 
<p><b>LAMPS .34</b></p> 		<p><b>STANDS .35</b></p> 	<p><b>BAGS .36</b></p> 		<p><b>PROMOTIONAL MATERIAL .37</b></p> 



## THE ORIGINAL NAIL GEL

BIOGEL is the original, professional, soak-off, easy wear nail gel system in a jar. With a 5-star Safety Rating boasting natural nail health, while beautifully enhancing and transforming any nail. A scientifically formulated pure gel range which varies from flexible to solid, BIOGEL is suitable for every nail type and is excellent for extending & strengthening nails. BIOGEL is durable, chip resistant, self levelling, with a long-lasting gloss finish, and removes within 10 to 15 min. With a range exceeding 200 colours, nail art and overlay possibilities are endless. New fashionable colours are launched seasonally, adding to the BIOGEL range with a matching nail polish range.

Treatment gels are available in:

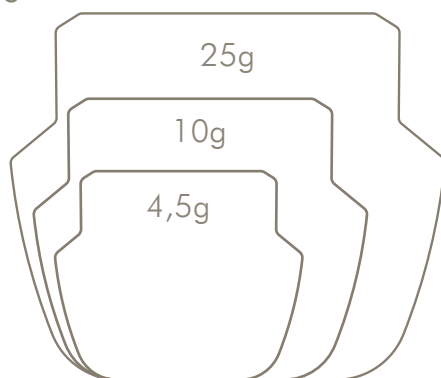

### Soft Gel

4,5g Item Code: 12\_4  
10g Item Code: 12\_10  
25g Item Code: 12\_25

Base layer and upper arch strengthening layer to soft, flexible nails. Soft Gel provides strength and support to the nail, yet still complimenting the natural nails flexibly. Ideal to seal nail art / French overlay.



### Base Gel

4,5g Item Code: 09\_4  
10g Item Code: 09\_10  
25g Item Code: 09\_25

Original Base Gel. Base layer promoting good and long lasting product adhesion to the natural nail. Base layer and upper arch strengthening layer to healthy nails. Base Gel provides strength and support to the nail, yet still complimenting the natural nails flexibly. Ideal to saturate silk.



### Conditioning Gel+

4,5g Item Code: 27\_4  
10g Item Code: 27\_10  
25g Item Code: 27\_25

Conditioning Gel is a specialised base gel which offers extraordinary adhesion for thin, sore, damaged, dry and distressed nails. This enriched base gel conditions the nail plate, promoting nail health in a concealer-foundation colour. See results after just one application.







### Gloss Gel

4,5g Item Code: 13\_4  
10g Item Code: 13\_10  
25g Item Code: 13\_25

Protective high gloss, scratch resistant gel finish to all overlay applications. Suitable for all nail types and keeps the overlay looking beautiful for weeks.



### Apex Gel

4,5g Item Code: 25\_4  
10g Item Code: 25\_10  
25g Item Code: 25\_25

Designed to create supreme strength, with a firm viscosity for creative wet gel shaping. The innovative technology of Apex Gel allows it to be applied as an upper arch strengthening layer on medium to hard nails, or as a strong support on long nails and extensions.



### Free Edge Gel

4,5g Item Code: 14\_4  
10g Item Code: 14\_10  
25g Item Code: 14\_25

Firm texture lengthening gel used to create form and silk sculpture applications, in a natural free edge colour. Provides a strong and durable free edge finish in various nail shapes and lengths.



### Pink Paste

4,5g Item Code: 15\_4

- Used as a concealer
- Illusion of an extended nail plate
- Applied with a puffer

## BIOGEL Colour Gel range

- 200+ Colours
- Non-chip nail colour
- Wide range of every day wear + fashionable colours
- Delicate shimmers + glitters
- Adds firmness to overlay
- Instantly dry after UV Led curing
- 30 second curing
- Applied in 2 layers
- Stix available for every colour

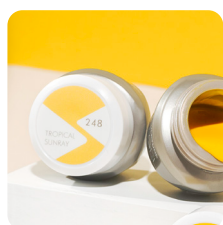
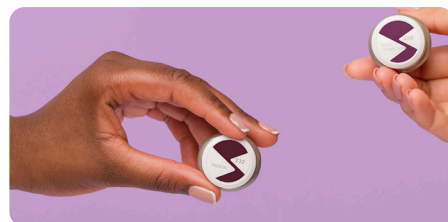
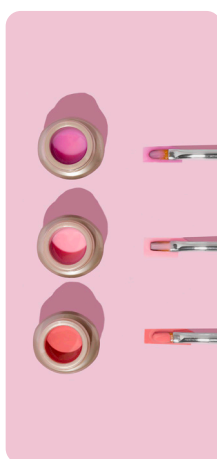



## GEL POLISH

EVO is a revolutionary, professional LED gel polish in a bottle system that is easy to apply. Consisting of three pure gel base coats: EVO Oxygenating Base & Build, EVO FLEX Base and EVO CONTOUR Base & Build, each with a unique texture and purpose to suit every nail type. The bases have excellent self levelling properties for overlays, adding strength to the natural nail and to create effortlessly create beautiful nail enhancements.

The bottle and brush system allow for fast application and quick removal within 10 to 15 min, while being a complete system on its own, EVO is compatible with BIOGEL. EVO has a wide selection of highly pigmented colour gels with excellent consistency and intense nail coverage that are all named after special ladies. Colour palettes are compiled together by leading fashion experts, adding new, seasonal and trendy colours as well as everyday wear shades to the EVO family.



### Flex

Base

- Ideal for soft, thin, brittle nails
- Extreme flexibility
- Flexible overlay support

14ml Item Code: EFLEX



### Oxygenating

Base & Build

- Medical grade formulation
- Permeable base layer
- Infused with vitamin A & E
- Builds a strong upper arch
- Form & silk sculptures
- Full Cover Tips

14ml Item Code: EBASEOXY



### Contour

Base & Build

- Ideal for normal to strong nails
- Durable and solid
- Strong support for long nails
- Contour a perfect arch
- Form & silk sculptures

14ml Item Code: ECONTOUR



## Chrome

Catalyst

- Applied before a chrome powder
- Long lasting chrome effect

10ml Item Code: E062



## Suede Matte

Top Coat

- Soft touch velvet finish
- Long lasting matte effect
- Non-wipe top coat

14ml Item Code: ETOPSUEDE



## Natural White

Free Edge Extension Gel

- Firm natural white builder gel
- Lengthen the free edge of the nail
- Natural free edge colour

12ml Item Code: E003



## Gloss

Top Coat

- Long lasting high shine
- Plumping effect
- Leaving the overlay looking beautiful for weeks

14ml Item Code: ETOPGLOSS

## Evo Gel Colour Range

EVO has a wide selection of highly pigmented colour gels with excellent consistency and intense nail coverage, named after special ladies. Colour palettes are compiled by leading fashion experts, adding seasonal and trendy colours, as well as everyday wear shades to the EVO Family. Six available for every colour.

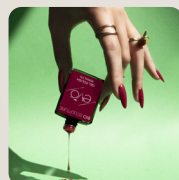
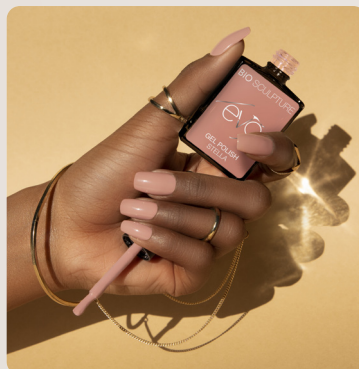
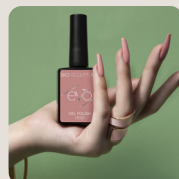
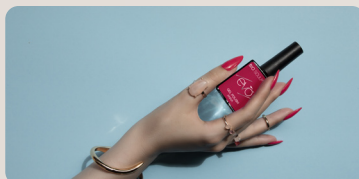
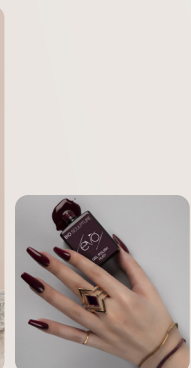



# BI-OLYGEL

BI-OLYGEL is a UV gel, strengthened with acrylic paste to bring out the best properties of both gel and acrylic systems, creating a firm hard gel in a 30g tube, that is easy and quick to apply.

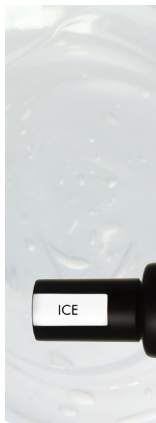

## Ice

30g Item Code: 200BG001

Clear gel that can be used to create glass-like sculptures



## Frost

30g Item Code: 200BG002

White gel that can be used to create a French free-edge or 3D nail art

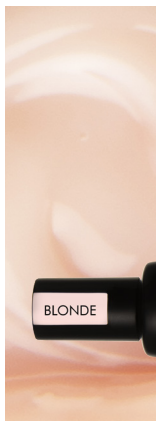

## Blonde

30g Item Code: 200BG003

Soft nude shade gel



## Glow

30g Item Code: 200BG004

Sheer pink gel that brings a healthy glow to nails



# ETHOS

ETHOS is the Nail Care range for natural nails by BIO SCULPTURE, pledged to Nail HEALTH. The unique property of the key natural ingredient in each individual treatment is discretely displayed on its bottle. Ideal for professional salon use and home care. Each product in this range has a unique scent, colour and formulation used to support, soothe, moisturise or strengthen your natural nails.



## Vitamin Dose

A combination of vitamins to rejuvenate, moisturise and nourish nails. Infused with ginseng root extract to sustain the keratin structure and cell metabolism of the nail.

14ml | Item Code: 303/14



## Cuticle Remover

Specially designed to soften hard, dry and stubborn cuticles during nail preparation. Enhances the finish and longevity of a nail treatment.

14ml | Item Code: 300/14



## Passion Berry Exfoliant

A nail and cuticle scrub with soft alumina particles and passiflora edulis seed powder that will help to remove dry and dead cells. Kukui nut oil provides anti-oxidant properties as well as anti-aging vitamin E and ginseng root extract to nourish nails and cuticles.

14ml | Item Code: 324/14



## Kiwi Scrub

Contains passion fruit seed powder that will exfoliate and rehydrate dry nails and cuticles. Added vitamin C and E, ginseng root extract, sunflower oil and sweet almond oil which will moisturise and hydrate nails.

14ml | Item Code: 318/14



## SPS

This unique acid-free pre-gel / pre-polish treatment allows for enhanced product adhesion. It maintains a healthy moisture balance, thus allowing for easier gel removal.

14ml | Item Code: 320/14



## Volcanic Base

Enriched by volcanic stone extract to give strength to soft nails. Rich in pistachio oil to help increase nail hardness as well as flexibility.

14ml | Item Code: 316/14



## Seaweed Calcium Base

Red alga seaweed extract to help strengthen keratin structures, increasing flexibility and suppleness to brittle nails. Silica and mica leaving a smooth nail surface on ridged nails. Used as a ridge filler under GEMINI polish application.

14ml | Item Code: 317/14



## Lavender Base

Promotes natural nail health. Baobab seed and carefully selected oils to improve the natural health of the nail.

14ml | Item Code: 304/14



### Mirror Top Coat

Smooth and silky nail polish top coat to finish GEMINI applications. It has a plumping effect that increases the brilliancy of the GEMINI polish colour, resists scratching and has a long-lasting, high gloss mirror-like shine that extends the longevity of a GEMINI treatment.

14ml | Item Code: 306/14



### Blackcurrant Cuticle Oil

Contains sweet almond, sunflower and blackcurrant seed oils that are anti-oxidant with softening properties for cuticle protection. Promotes cell regeneration for a youthful appearance.

14ml | Item Code: 321/14



### Jasmine Cuticle Oil

Contains borage oil which is anti-inflammatory and has detoxifying properties. Sunflower and sweet almond oils promote healthy nail growth and long-lasting nourishment.

14ml | Item Code: 322/14



### Rosehip Cuticle Oil

A unique composition of oils including rosehip and camelia oil smooths rough and dry patches, locking moisture into nails and cuticles to keep them nourished and hydrated.

14ml | Item Code: 323/14

### Almond Oil

Infused with almond oil and extracts to combat dry nails and cuticles. Contains almond, jojoba, avocado and vitamin E oils, to rehydrate nails and keep cuticles and surrounding skin supple.

14ml | Item Code: 302/14



### ETHOS Bundle

- Vitamin Dose
- Cuticle Remover
- Kiwi Scrub
- SPS
- Volcanic Base
- Seaweed Calcium Base
- Lavender Base
- Mirror Top Coat
- Blackcurrant Cuticle Oil
- Almond Oil

14ml | Item Code: COL/ETHOS

## ETHOS 50ML REFILLS



### Cuticle Remover

Item Code: 300/50



### Vitamin Dose

Item Code: 303/50



### Almond Oil

Item Code: 302/50



# GEMINI

## NOURISHING NAIL POLISH

These fast drying and long-lasting colours are available in many shades to suit your style and personality, beautifully packaged in a 14ml bottle. They match BIOGEL's colours, and they leave you feeling confident to take on the day or on trend to party the night away.

- ✔ Easy to apply
- ✔ Long Lasting
- ✔ Fast Drying



# NAIL ART



## White Screed

A sturdy white builder gel used to extend a solid white free edge and create top surface nail art designs.

Art Gel 10g Item Code: 15\_10  
Art Gel 25g Item Code: 15\_25



## Liquid Glass

High viscosity nail art gel used to sculpt 3D nail art designs. Liquid Glass may be used to create clear images or it can be used in conjunction with BIO SCULPTURE's High Pigment Gels to build colourful nail art masterpieces.

7g Art Gel Item Code: 200STLG

# THREADING GEL

A high viscosity gel with tangy threading properties used to create effortlessly beautiful nail art.

## Black

Threading Gel 4,5g Item Code: 19\_4

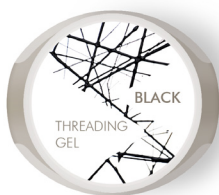

## White

Threading Gel 4,5g Item Code: 18\_4



## Gold

Threading Gel 4,5g Item Code: 20\_4



## Silver

Threading Gel 4,5g Item Code: 21\_4



## Red

Threading Gel 4,5g Item Code: 23\_4



## Blue

Threading Gel 4,5g Item Code: 22\_4

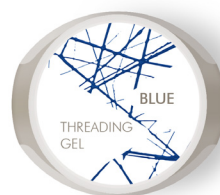

# HP GELS

Highly pigmented gels, used by award winning nail technicians all over the world. HP Gels are extremely easy to work with and allow for endless nail art creations.

## Pink

3g HP Art Gel Item Code: 200ST001



## Purple

3g HP Art Gel Item Code: 200ST002



## Blue

3g HP Art Gel Item Code: 200ST003



## Turquoise

3g HP Art Gel Item Code: 200ST004



## Red

3g HP Art Gel Item Code: 200ST005



## Yellow

3g HP Art Gel Item Code: 200ST008



## Green

3g HP Art Gel Item Code: 200ST010



## Black

3g HP Art Gel Item Code: 200ST011



## White

3g HP Art Gel Item Code: 200ST012



## Gold

3g HP Art Gel Item Code: 200ST013



## Silver

3g HP Art Gel Item Code: 200ST014



# NAIL ART KIT

BIO SCULPTURE's Nail Art Kit comes fully equipped with everything you need to start off your Nail Art Career. The kit consists of:

- 8 high pigmented gels, these HP Gels are used by award winning nail technicians all over the world. HP Gels are extremely easy to work with and allow for endless nail art creations.
- The 8 Stencils are a quick and effective tool used to create effortlessly beautiful nail art. Stencils are only a 'puff' away from a perfect design.
- 8 Puffers used to apply HP gels to the nail, create stencil designs and help achieve the perfect Ombre.
- 1 Metal plate used as a creative plate to mix and decant high pigment gels.

Item Code: KIT/431





# STENCILS



## Festive Stencils

Stencils are a quick and effective tool used with HP gels to create effortlessly beautiful nail art.

Pack of 5 | Item Code: NART/941

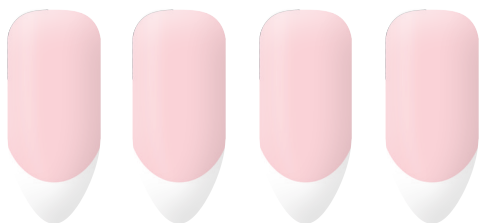

## French Stencil / French Circle Stencils

A French circle stencil pack used with HP gels to help create the perfect French smile line.

Pack of 4 | Item Code: NART/938



## Shape Stencils

Stencils are a quick and effective tool used with HP gels to create effortlessly beautiful nail art. Stencils are only a 'puff' away from a perfect design.

Pack of 9 | Item Code: NART/940

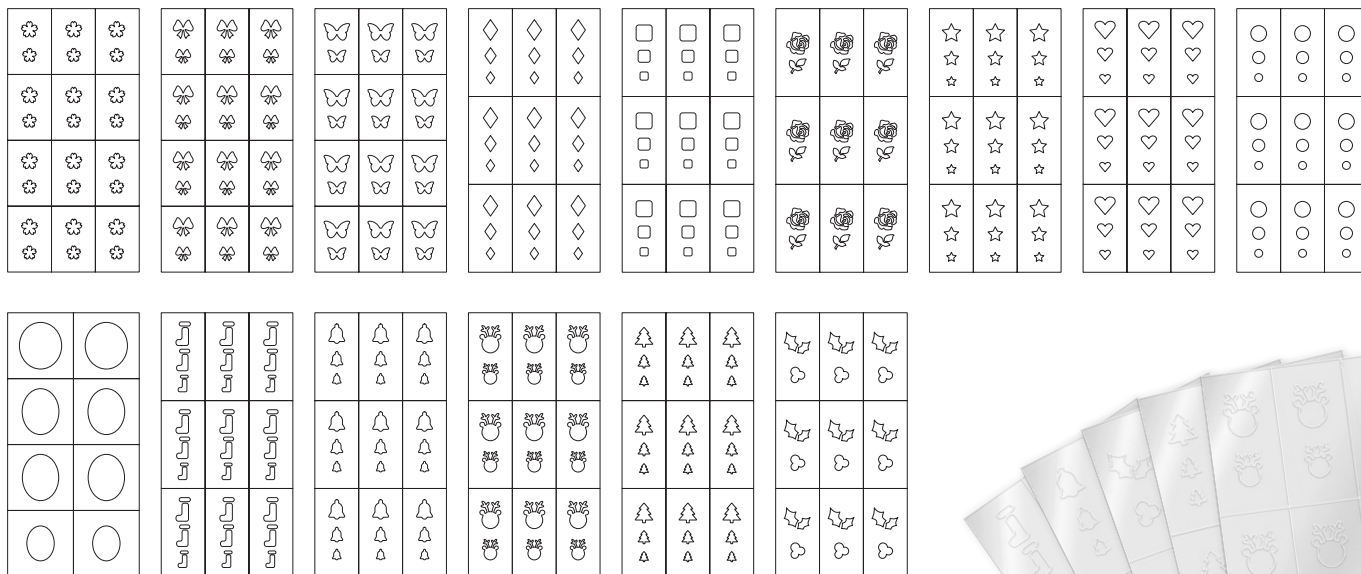

# CARMEN

Carmen perfume is youthful and light, with smooth warming elements carrying the fragrance of a sacred love that lingers. A refreshingly happy celebration of life!



**100ml Carmen**

100ml with Mink Ball Item Code: 350/100/R  
100ml with Synthetic Ball Item Code: 350/100/S



**15ml Carmen**

15ml Item Code: 350/14



**Carmen Scent Stick**

Pack of 50 | Item Code: PRO/1367



**Carmen Stand**

Item Code: STAND/CPS



*celebrating life*

# SPA

Inspired by nature, BIO SCULPTURE's tranquil SPA treatment range can be used in salon or at home. Specially blended and formulated to exfoliate, hydrate, protect, and soften the skin and cuticles. Delivering essential nutrients to rejuvenate the health and beauty of your skin and nails.



## Potpourri Aqua Soak

Delightful, citrus scented bath and foot-spa soak that soothes and softens the skin.

180g Item Code: 501/250  
540g Item Code: 501/750  
1.5Kg Item Code: 501/1500



## Hand & Body Butter

A rich textured moisturiser for dry and dehydrated skin, leaving a healthy looking glow.

250ml Item Code: 505/250  
750ml Item Code: 505/750  
2l Item Code: 505/2000



## Apricot Kernel Scrub

Cream scrub for gentle exfoliation with natural apricot kernels and pumice.

250ml Item Code: 503/250  
750ml Item Code: 503/750  
2l Item Code: 503/2000



## Potpourri Salt Scrub

An exfoliating sea salt scrub with light botanical oils and real rose petals leaves skin silky smooth with a heavenly scent.

250ml Item Code: 502/250  
750ml Item Code: 502/750  
2l Item Code: 502/2000





## Mint Mask

Moisturising mask that creates a lovely cooling effect, leaving skin feeling relaxed, nourished and rejuvenated.

100ml Item Code: 504/100  
 250ml Item Code: 504/250  
 750ml Item Code: 504/750



## Heel Balm

Heel Balm is a nourishing, deep moisturising treatment applied to dry, cracked heels and feet.

75ml Item Code: 510/75  
 250ml Item Code: 510/250  
 750ml Item Code: 510/750



## Hand Cream

Hand Cream moisturises, leaving hands soft and silky. Conveniently packaged in a 75ml tube

75ml Item Code: 506/75



## Cuticle Cream

An enriched nourishing cream that softens the cuticles.

20ml Item Code: 507/20



## Hand Wash

Soft, refreshing silk-textured liquid soap with a beautiful geranium fragrance.

100ml Item Code: 509/100  
 200ml Item Code: 509/200  
 1 l Item Code: 509/1L



## Hand & Body Lotion

Moisturises and nourishes, leaving skin smooth. Ideal as a home care product.

200ml Item Code: 508/200  
 1 l Item Code: 508/1L

# SOLVENTS

BIO SCULPTURE has a range of specially designed solvents in convenient sizes. Tried and tested to compliment all of our product lines.



## Quick Dry

Spray on nails after GEMINI polish is applied to help a nail polish manicure dry quickly.

50ml Item Code: 707/50  
200ml Item Code: 707/200



## Remover Sachets

Used to safely remove BIOGEL and EVO applications within 10 -15 minutes.

Pack of 100 | Item Code: ES/105B



## Hygiene Prep

Spray to sanitise files, utensils and clients nails. Used with nail plate separation or fungal infection.

50ml Item Code: 710/50  
200ml Item Code: 710/200



## Slide Solution

Slide Solution is a wetting solution, used to keep BI-OLYGEL's moist and easy to manipulate when shaping or building BI-OLYGEL overlays and sculptures.

50ml Item Code: 711/50  
200ml Item Code: 711/200



## Dilute

Dilutes dry, thickened nail polish.

50ml Item Code: 706/50



## Cleanser

Cleanser allows for quick nail polish removal as well as effortless cleansing during and after gel application.

200ml Item Code: 703/200  
1 l Item Code: 703/1L



## Gel Remover

Specially designed to improve the gel removal process, with a soft green tint for easy identification and an aloe vera scent to enhance your treatment experience.

200ml Item Code: 705/200  
1 l Item Code: 705/1L



## Surface Cleaner

Registered as a BFR Biocidal. Alcohol percentage of 70.45%. Used in private, public and industrial areas to disinfect surfaces, materials, equipment and furniture.

200ml Item Code: 709/200  
1 l Item Code: 709/1L



## Techniclean

Waterless hand cleanser. Alcohol percentage of 55.05%.

100ml Item Code: 511/100

# SUMMER HEEL

BIO SCULPTURE Summer Heel is a safe, quick and easy callus removal treatment. Visible results within minutes, achieved by using products suitable for both salon and home use.



## Summer Heel Professional Kit

The complete kit for safe and effective callus removal in salon.

- Callus Removal Patches
- 50ml Summer Heel Spritz
- 75ml Heel Balm
- Scraper
- Black Nitrile Gloves
- Foot File

Item Code: KIT/407



## Summer Heel Home Care Pack

The perfect solution for safe callus removal at home.

- Pumice Stone
- 50ml Summer Heel Spritz
- 75ml Heel Balm

Item Code: KIT/408



### Spritz

PH balanced spray-on callus removal solution. For professional or home use.

50ml Item Code: 512/50



### Callus Removal Patches

Pre-saturated callus removal patches. Hygienically packed in a foil pouch for professional convenience.

Box of 10 | Item Code: 512/S



### Scraper

Specially designed to effectively remove softened skin.

Item Code: UT/806



# KITS



## Complete Career Training Kit

(5 day career training) *Deluxe Item Code: KIT/405*  
*Ultra Item Code: KIT/405/U*

- Carry Bag
- Home Care Bag
- BIOGEL Technician Manual
- EVO Technician Manual
- Spa Training Manual
- Client Record Card
- BI-OLYGEL Brochure
- BIOGEL Brochure
- EVO Brochure
- Deluxe LED Unit / Ultra Curing Lamp
- LED Adaptor
- Technician Badge
- Catalogue
- Colour Booklet
- BIOGEL**
- 4.5g Base Gel
- 4.5g Soft Gel
- 4.5g Apex Gel
- 4.5g Free Edge Gel
- 4.5g Gloss Gel
- 4.5g Gel No. 1 French White
- 4.5g Gel No. 30 Triginta
- EVO**
- EVO Oxygenating Base & Build
- EVO Flex Base
- EVO Contour Base & Build
- EVO Gloss Top Coat
- EVO Gel 121 Stella

- ETHOS & GEMINI**
- 14ml ETHOS Cuticle Remover
- 14ml ETHOS Almond Oil
- 14ml ETHOS Vitamin Dose
- 14ml ETHOS SPS
- 14ml ETHOS Lavender Base
- 14ml ETHOS Mirror Top Coat
- 14ml GEMINI Polish No. 30 Triginta

- SPA**
- 250ml Potpourri Aqua Soak
- 100ml Apricot Kernel Scrub
- 100ml Mint Mask
- 250ml Hand & Body Butter
- Spa Spatula

- SOLVENTS**
- 200ml Cleanser (Menda Pump)
- 200ml Gel Remover (Spout)
- 200ml Surface Cleaner & S/Pump
- 50ml Hygiene Prep & S/Pump
- BIO SCULPTURE Cleanser Sachets x5
- BIO SCULPTURE Remover Sachets x5

- SOFTS**
- Nail Wipes Set (X50)
- Wonder Wipe (X1 Roll)
- Cotton Wipes (X200)
- Silk Strip (Piece)
- Advanced Nail Forms (50)

- BUFFS & FILES**
- Thin Black File (150/200 Grit) X6
- Multi-File Handle X2
- Orange Spear Patch (100 Grit) X1
- Grey Square Patch (220 Grit) X1
- Black File Patch (180 Grit) X1
- Blue File Patch (100 Grit) X1
- Gold File (100/100 Grit) X1

- UTENSILS**
- Metal Tool Large
- Side Blade Cutter
- Metal Pick
- Bio Tweezers
- Gel Brush Holder
- Large Metal Stirrer
- Straight Blade Silver Stork Scissors
- Finger Rest
- Full Cover Tips (Almond Medium)
- Flashlight
- Dampen Dish

- BRUSHES**
- Upper Arch Brush
- Gel Brush #6 Round
- Gel Brush #4 Flat
- Gel Brush #4 French
- Nail Brush
- Mask Brush

## BI-OLYGEL Kit

*Item Code: KIT/416*

- Pedicure Bag
- BI-OLYGEL Manual
- Catalogue
- BI-OLYGEL Blonde
- BI-OLYGEL Frost
- BI-OLYGEL Ice
- BI-OLYGEL Brochure
- SOFTS**
- Advanced Nail Forms x50
- SOLVENTS**
- 50ml Slide Solution

- BUFFS & FILES**
- Purple Buff (80/80 Grit) x1
- White Patches (80 Grit) x2
- UTENSILS**
- Silicone Tool
- Clips x10
- Sculpture Moulds
- Dampen Dish
- BRUSHES**
- BI-OLYGEL Brush





## BIOGEL Training Kit

Item Code: KIT/404

- Carry Bag
- Home Care Bag
- BIOGEL Technician Manual
- Client Record Card
- BI-OLYGEL Brochure
- BIOGEL Brochure
- EVO Brochure
- Deluxe Led Unit
- Led Adaptor
- Technician Badge
- Catalogue
- Colour Booklet

## EVO Training Kit

Item Code: KIT/E/TRAIN

- Carry Bag
- Home Care Bag
- EVO Technician Manual
- Client Record Card
- BI-OLYGEL Brochure
- BIOGEL Brochure
- EVO Brochure
- Technician Badge
- EVO Led Unit With Adaptor
- Catalogue
- Colour Booklet

### EVO

- EVO Flex Base
- EVO Contour Base & Build
- EVO Oxygenating Base & Build
- EVO Gloss Top Coat
- EVO Gel 121 Stella
- EVO Gel 001 Whitney
- EVO Gel 003 Natural White

### SOFTS

- Nail Wipes Set (X50)
- Wonder Wipe (X1 Roll)
- Cotton Wipes (X200)
- Silk Strip (Piece)
- Advanced Nail Forms (50)

## Home Care Retail Pack

Item Code: KIT/401

- 14ml ETHOS Kiwi Scrub
- 14ml ETHOS Vitamin Dose
- 14ml ETHOS Lavender Base
- 14ml ETHOS Almond Oil
- Thin Black File
- BIO SCULPTURE Remover Sachets x12

Tutorial video:

<https://youtu.be/fgxMH3kLT2c>

### BIOGEL

- 4.5g Base Gel
- 4.5g Soft Gel
- 4.5g Apex Gel
- 4.5g Free Edge Gel
- 4.5g Gloss Gel
- 4.5g Gel No. 1 French White
- 4.5g Gel No. 30 Triginta

### SOFTS

- Nail Wipes Set (X50)
- Wonder Wipe (X1 Roll)
- Cotton Wipes (X200)
- Silk Strip (Piece)
- Advanced Nail Forms (50)

### ETHOS & GEMINI

- 14ml ETHOS Cuticle Remover
- 14ml ETHOS Almond Oil
- 14ml ETHOS Vitamin Dose
- 14ml ETHOS SPS
- 14ml ETHOS Lavender Base
- 14ml ETHOS Mirror Top Coat
- 14ml Gemini Polish No. 30 Triginta

### SOLVENTS

- 200ml Cleanser (Menda Pump)
- 200ml Gel Remover (Spout)
- 200ml Surface Cleaner & S/Pump
- 50ml Hygiene Prep & S/Pump

### ETHOS

- 14ml ETHOS Lavender Base
- 14ml ETHOS Cuticle Remover
- 14ml ETHOS Almond Oil
- 14ml ETHOS Vitamin Dose
- 14ml ETHOS SPS

### SOLVENTS

- 200ml Cleanser (Menda Pump)
- 200ml Gel Remover (Spout)
- 200ml Surface Cleaner & S/Pump
- 50ml Hygiene Prep & S/Pump
- BIO SCULPTURE Cleanser Sachets x5
- BIO SCULPTURE Remover Sachets x5

### BUFFS & FILES

- Thin Black File (150/200 Grit) X6
- Multi-File Handle X2
- Orange Spear Patch (100 Grit) X1
- Grey Square Patch (220 Grit) X1
- Black File Patch (180 Grit) X1
- Blue File Patch (100 Grit) X1
- Gold File (100/100 Grit) X1

### BUFFS & FILES

- Thin Black File (150/200 Grit) X6
- Multi-File Handle X2
- Orange Spear Patch (100 Grit) X1
- Grey Square Patch (220 Grit) X1
- Black File Patch (180 Grit) X1
- Blue File Patch (100 Grit) X1
- Gold File (100/100 Grit) X1

### UTENSILS

- Metal Tool Large
- Side Blade Cutter
- Metal Pick
- BIO Tweezers
- Gel Brush Holder
- Large Metal Stirrer
- Straight Blade Silver Stork Scissors
- Finger Rest
- Full Cover Tips (Almond Medium)
- Flashlight
- Dampen Dish

### BRUSHES

- Upper Arch Brush
- Gel Brush #6 Round
- Gel Brush #4 Flat
- Gel Brush #4 French
- Nail Brush



### UTENSILS

- Metal Tool Large
- Side Blade Cutter
- Metal Pick
- BIO Tweezers
- Gel Brush Holder
- Large Metal Stirrer
- Straight Blade Silver Stork Scissors
- Finger Rest
- Full Cover Tips (Almond Medium)
- Flashlight
- Dampen Dish

### BRUSHES

- Gel Brush #6 Round
- Nail Brush
- Evo Nail Art Brush (In Bottle)
- Evo French Brush (In Bottle)



# UTENSILS

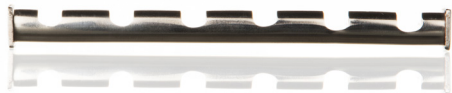

## Gel Brush Holder

Hold and organise gel brushes and utensils during treatments.

Item Code: UT/800



## Metal Tool

Push back cuticles, prepare nail plate and remove excess gel during soak off process  
Available in small or large.

Large Metal Tool Item Code: UT/802/L

Small Metal Tool Item Code: UT/802/S



## Cuti-Stone

Remove loose dead skin around cuticles and side walls during nail plate preparation.

Item Code: UT/803



## Metal Stirrer

Stir, mix and fold BIOGEL colour gels.

Large Metal Stirrer Item Code: UT/809/L

Small Metal Stirrer Item Code: UT/809/S



## Silicone Tool

Specially designed tool used to create beautiful and effortless 3D BI-OLY GEL nail art and also to apply chrome powders.

Item Code: UT/NA492



## Dotting Tool

Create various nail art techniques.

Purple Dotting Tool Item Code: UT/816/P

Crystal Dotting Tool Item Code: UT/816/C





## Edge Cutter

Shorten free edge length on tips and sculptures during application and gel removal.

Item Code: UT/811



## Bio Tweezers

Assists in soak off process to pick up and place the Cotton Square soaked in Gel Remover onto clients nails to avoid over exposure to product. Shape and squeeze a perfect c-curve when building silk sculptures.

Item Code: UT/810



## Cuticle Nipper

Nip excess dead cuticles during nail plate preparation.

Item Code: UT/805



## Sapphire Tool

Push back cuticles, file the free edge or hard skin on the side of the finger and remove dust from the nail.

Item Code: UT/807



## Straight Blade Silver Scissors

Long blade scissor used to cut silk and cut nail forms.

Item Code: UT/814



## Straight Blade Silver Stork Scissors

Long blade scissors used to cut and shape silk and nail forms.

Item Code: UT/813/SB



## Side Blade Cutter

Cut hang nails and loose skin during nail plate preparation.

Item Code: UT/804



## Large Nail Clipper

Shorten nail length.

Item Code: UT/818



### Finger Rest

Rest clients finger during Full Cover Tip application or detailed Nail Art application.

Item Code: UT/817



### Dampen Dish

Hold BI-OLYGEL Slide Solution while working with BI-OLYGEL, Gel Remover when cleaning gel brushes and solution for certain nail art techniques.

Item Code: UT/815



### Puff with Silver Handle

Puffers are used to apply HP gels to the nail, create stencil designs and to achieve a perfect ombre.

Pack of 2 | Item Code: UT/924



### Metal Pick

Remove gel or nail polish that has touched skin around the nail.

Item Code: UT/822



### Prep Dish

Hold solution with cleaning gel brushes, solutions for nail art or mix HP gels for nail art techniques.

Item Code: UT/823



### SPA Spatula

A hygienic spatula used for the dispensing of Spa Products.

Item Code: UT/SPT



### Flower Magnet

A flower magnet used to create magnetic effects for selected magnet effect gels.

Item Code: UT/935



### Metal Plate

Used as a creative plate to mix and decant HP gels.

Item Code: UT/934



### Clips

BI-OLYGEL Clips are used to assist in shaping perfect c-curves when creating extreme length.

Pack of 10 | Item Code: UT/CLIP



### EVO Gel Magnet

A magnet used to create a magnetic line effect for selected EVO Gels.

Item Code: UT/E/MAGNET/5D

# MANUALS

BIO SCULPTURE's professional gel products are available to nail technicians through brand training. As a training-based system, BIO SCULPTURE endorses the highest standard globally and produces award winning nail technicians worldwide. There is a specialised manual for each and every one of our training modules. These manuals will assist you in becoming a certified BIO SCULPTURE technician. Once you are a qualified BIO SCULPTURE nail technician make sure you have the latest manual and are up to date with the newest application methods.



**BIOGEL Technician Manual**

Item Code: MAN/1603



**EVO Manual**

Item Code: MAN/EVO



**SPA Manual**

Item Code: MAN/1605



**Full Cover Tip Manual**

Item Code: MAN/1601



**Nail Art Manual**

Item Code: MAN/1600



**Summer Heel Manual**

Item Code: MAN/1602



**BI-OLYGEL Manual**

Item Code: MAN/1628



# TIPS & ADHESIVE

## FULL COVER TIPS

BIO SCULPTURE Full Cover Tips are clear, pre-cut, shaped tips used to create perfect extensions. The tip application provides consistent length and shape on all 10 nails.



### Coffin Medium

A chic, medium length coffin shape gives you a modern feel.

360pc | Size 0-9  
Item Code: TA/NAI006



### Square Medium

A classic, the medium length square shape is a comfortable everyday wear shape.

360pc | Size 0-9  
Item Code: TA/NAI002



### Coffin Long

A stylish, long length coffin shape leaves you feeling bold and adventurous.

208pc | Size 0-9  
Item Code: TA/NAI010



### Round Medium

The traditional medium length round shape will always stand the test of time.

360pc | Size 0-9  
Item Code: TA/NAI004

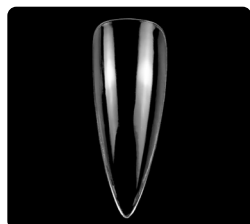

### Stiletto Long

The striking long stiletto is a daring showstopper.

360pc | Size 1-9  
Item Code: TA/NAI005

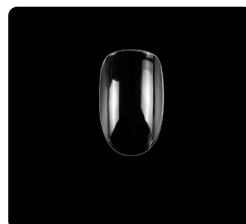

### Oval Short

A comfortable short oval shape gives a natural look and feel.

360pc | Size 0-9  
Item Code: TA/NAI001

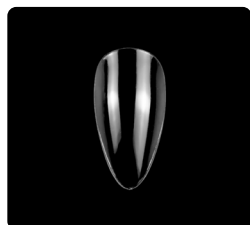

### Almond Medium

This sophisticated medium length almond shape is impressively elegant.

360pc | Size 0-11  
Item Code: TA/NAI003



### LED Curing Flashlight

The UV LED Flashlight is designed to par cure a glueless tip application with ease and simplicity.

Item Code: CUR/PHH



### Refill Pack No. 9 Regular

50 Pack | Item Code: TA/125/R9



### Refill Pack No. 8 Regular

50 Pack | Item Code: TA/125/R8



### Refill Pack No. 7 Regular

50 Pack | Item Code: TA/125/R7



### Refill Pack No. 6 Regular

50 Pack | Item Code: TA/125/R6



### Refill Pack No. 5 Regular

50 Pack | Item Code: TA/125/R5



### Refill Pack No. 4 Regular

50 Pack | Item Code: TA/125/R4



### Refill Pack No. 3 Regular

50 Pack | Item Code: TA/125/R3



### Refill Pack No. 2 Regular

50 Pack | Item Code: TA/125/R2



### Refill Pack No. 1 Regular

50 Pack | Item Code: TA/125/R1



### Refill Pack No. 0 Regular

50 Pack | Item Code: TA/125/R0



### Brush On Nail Resin

10ml | Item Code: TA/122/BO



### Box with 250 Regular Tips

Item Code: TA/123/BXR



### BI-OLYGEL Sculpture Moulds

100pcs - 10 Sizes  
Item Code: TA/120/BRT

# SOFTS



## Cotton Squares

Used for gel and polish removal. Remove the sticky residue once the final layer of gel is complete.

Pack of 200 | Item Code: SFT/901



## Wonderwipe Roll

Cotton roll used for gel and polish removal or to remove the sticky residue once gel is cured, right at the end of a gel overlay.

Pack of 6 | Item Code: SFT/902



## Cotton Wipes

Cotton nail wipes used during gel and nail polish application.

Pack of 200 | Item Code: SFT/906



## Nail Wipes

Lint free nail wipes used during gel and nail polish application.

Pack of 360 | Item Code: SFT/903



## Silk Strip

Used to create silk sculptures and to repair stress breaks on nails.

Item Code: SFT/904

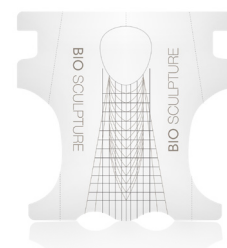

## Advanced Nail Forms

Used to lengthen the natural nail, creating various nail lengths and shapes with effective side wall alignment. May be shaped, cut and moulded to fit any nail shape. Adhesive connection with creating sculptures.

Pack of 152 | Item Code: SFT/905/A





## Black Nitrile Gloves

Medium size disposable nitrile gloves. (Black)

Pack of 100 | Item Code: SFT/908/B



## Bio Gloves

Fingerless gloves used to protect and keep clients hands warm during gel removal as well as overlays.

Pack of 2 | Item Code: SFT/907



## Tootseez

Tootseez are used to separate toes during pedicures with doing a gel overlay or polish application.

Pack of 2 | Item Code: SFT/912



## Soakies

Soakies are used to assist in gel removal to hold nail foils and BIO SCULPTURE Remover Sachets in place.

Pack of 10 | Item Code: SFT/920



## Disposable Apron

Disposable plastic apron.

Pack of 100 | Item Code: SFT/913



## Apron

Item Code: TUN/Apron



## Pumice Stone

Abrasive stone used to remove dry skin.

Pack of 1 | Item Code: UT/821



## Nail Foils

Pre-cut foil squares used during the gel removal process.

Pack of 400 | Item Code: SFT/919

# BRUSHES



**No. 4 Flat Brush**

Flat bristle brush used to apply BIO-GEL and create nail art designs.

*Item Code: BR/111/4F*



**No. 4 Round Brush**

Round bristle brush used to apply BIOGEL and create nail art designs.

*Item Code: BR/111/4R*



**No. 4 Smiley Brush**

Round bristle brush used to create nail art designs and perfect a french smile line.

*Item Code: BR/111/4S*



**No. 4 French Brush**

Slanted bristle brush used to create nail art designs and the perfect French smile line.

*Item Code: BR/111/WF*



**No. 4 French Brush Crystal**

Slanted bristle brush used to create nail art designs and the perfect French smile line.

*Item Code: BR/111/WFC*



**No. 6 Flat Brush**

Flat bristle brush used to apply BIO-GEL and create nail art designs.

*Item Code: BR/112/6F*



**No. 6 Round Brush**

Round bristle brush used to apply BIOGEL and create nail art designs.

*Item Code: BR/112/6R*



**No. 6 Flat Retractable Brush**

Flat bristle brush used to apply BIO-GEL and create nail art designs.

*Item Code: BR/113/6R*



**Fine Art Brush**

High quality fine brush tip allows the technician to achieve the finest detailing and line work. Ideal for hand painting small and intricate designs.

*Item Code: BR/114/FN*



### Nail Art Brush

Short small bristle brush used to create nail art designs.

Item Code: BR/114/1N



### Upper Arch Brush

Long, thin brush tip used for detailing and to build an upper arch and create fine detail nail art.

Item Code: BR/115/UA



### BI-OLYGEL Handle Brush (2in1)

Specially shaped bristles to assist in contouring BI-OLYGEL when used in conjunction with Slide Solution.

Item Code: BR/120/BHB



### Dusting Brush

Soft bristle brush used to remove dust from clients hands and surfaces.

Item Code: BR/117



### EVO French Brush (In Bottle)

Slanted brush tip in an EVO bottle used to create a perfect French smile line.

Item Code: BR/E/FRENCH



### EVO Nail Art Brush (In Bottle)

Long, thin brush tip in an EVO bottle used to build an upper arch and create fine detail nail art.

Item Code: BR/E/NAILART



### Mask Brush

A soft bristle brush used to apply Mint Mask during manicures or pedicures.

Item Code: BR/118/S



### Massage Brush

A round brush with firm bristles used to assist in massaging during manicures and pedicures.

Item Code: BR/119



### Nail Brush

A nail brush used to remove dust off nail during preparation and overlays as well as clean under the nails after gel removal.

Item Code: BR/116

# BUFFS & FILES



## Turquoise Shiner

Ultra-fine turquoise buff used to buff and shine natural nails. 400/3000 grit.

Item Code: BF/1001/S



## Sponge Board

Orange and purple sponge board used to refine and shape gel layers. 100/180 grit.

Item Code: BF/1006



## Grey Square

Fine grey sponge buff board used to refine natural nails and gel layers. 220/220 grit.

Item Code: BF/1004/S



## Orange Spear

Coarse grit orange sponge spear used to refine and shape gel layers. 100/100 grit.

Pack of 5 Item Code: BF/1007



## Purple Buff

Coarse buff used to swiftly shape and buff hard or thick applications. 80/80 grit.

Item Code: BF/1020/S



## Gold File

A coarse grit file used to shape sculptures and tips and to file the top layers of gel during product removal. 100/100 grit.

Item Code: BF/1009/S



## Thin Black File

Small, mini black file used to shape the free edge of natural nails, gel overlays and assists in nail plate preparation and gel removal. 150/220 grit.

Pack of 6 | Item Code: BF/1008



## Black Teardrop

Medium grit file used to shape the free edge of natural nails. 100/180 grit.

Item Code: BF/1005/G/S



## Pink Teardrop

Fine pink file used to shape the free edge of natural nails. 280/320 grit.

Item Code: BF/1002/S





## Multi-File Handle

Hygienic file handle used with disposable stick-on file or buff patches.

Pack of 2 | Item Code: BF/1010



## White Patch

Pack of 20 | Item Code: BF/1021

Coarse White Patch is used on a Multi-File Handle to hygienically assist with a quicker and more efficient removal process. (80 grit)



## Blue Patch

Pack of 20 | Item Code: BF/1013

Coarse grit blue file patch used on a Multi-File Handle to file top layers of gel during the removal process. (100 grit)



## Black Patch

Pack of 20 | Item Code: BF/1011

Fine black file patch used on a Multi-File Handle to shape the free edge of natural nails and refine gel layers. (240 grit)



## Grey Patch

Pack of 10 Item Code: BF/1004/P

Fine grey sponge buff patch used on a Multi-File Handle to refine natural nails and gel layers. (220 grit)



## Orange Patch

Pack of 10 Item Code: BF/1007/P

Coarse grit orange sponge patch used on a Multi-File Handle to refine and shape gel layers. (100 grit)



## Purple Patch

Pack of 10 Item Code: BF/1020/P

Coarse buff patch used to swiftly shape and buff hard or thick applications. (80 grit)



## Large Pedi-Paddle

Hygienic file handle used with disposable stick-on Pedi-Paddle refills to remove dry and dead skin from the bottom of feet.

Item Code: BF/1015



## Large Pedi-Paddle Refills

Large Pedi-Paddle stick-on refills. 10x Fine (180 grit) and 10x Coarse (100grit).

Pack of 20 | Item Code: BF/1015/R

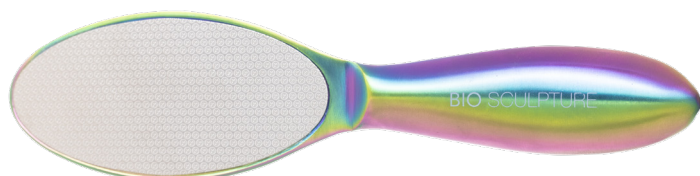

## Foot File

Durable double sided stainless steel foot file to remove dry skin from the bottom of the feet.

Item Code: UT/801

# LAMPS



## ULTRA Curing Lamp

Featuring multiple curing settings, use the sleek touchpad to select an optimum power curve for any BIO SCULPTURE gel. Intelligent power curve technology provides gentle curing to avoid heat spikes and ensures a proper through cure

- 10, 30, 60, 90 second curing
- Easy to use touch pad
- 30 Watts
- Auto on/off sensor
- Multiple curing settings
- Intelligent power curve
- Removable magnetic plate

Item Code: CUR/ULTRA/EU



## Professional LED Desk Lamp

Black Item Code: STAND/DL/B

Silver Item Code: STAND/DL/S



## V3 Deluxe LED Unit

- 30 second curing
- Automatic sensor
- Self-activation button
- Light weight
- 16 LED's
- Removable magnetic base plate
- Replaceable silicone base pad protector
- Good side wall and free edge curing

Item Code: CUR/V3/EU

# STANDS

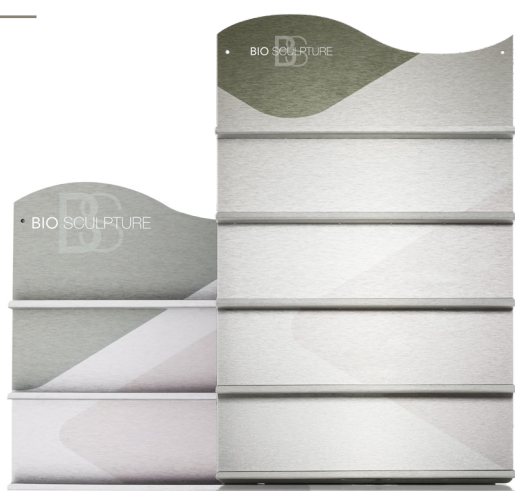

## Wall Display Stand

Holds 30x EVO/ETHOS/GEMINI bottles  
**Large** holds 50 bottles

Item Code: STAND/WUC  
 Large Item Code: STAND/WUC/L

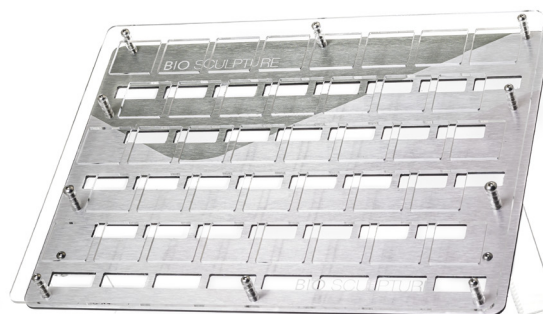

## Table Stand

Holds 38x EVO/ETHOS/GEMINI bottles

Item Code: STAND/TS



## Retail Display Stand

Holds 10x EVO/ETHOS/GEMINI bottles

Item Code: STAND/RDS



## Desk Organiser

Item Code: STAND/DO

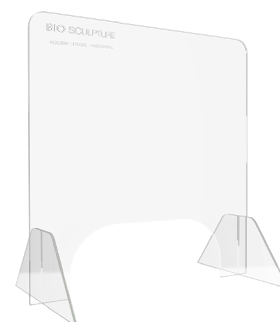

## Perspex Sneeze Guard

Item Code: STAND/PSG

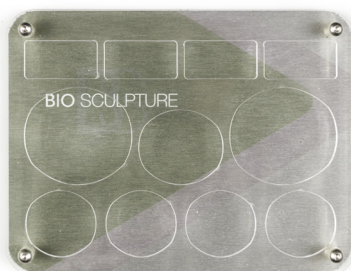

## Small Gel Tray

Holds:  
 4x EVO/ETHOS/GEMINI bottles  
 2x 25g BIOGEL jars  
 1x 10g BIOGEL jar  
 4x 4.5g BIOGEL jars

Item Code: STAND/ATS



## Duo Tray

Holds:  
 8x EVO/ETHOS/GEMINI bottles  
 8x 4.5g BIOGEL jars

Item Code: STAND/DT

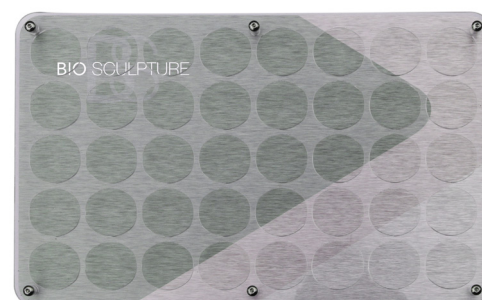

## BIOGEL Tray

Holds 40x 4.5g BIOGEL jars

Item Code: STAND/DESK



# BAGS



**Accessory Bag**

Item Code: BAG/411



**Carry Bag**

Item Code: BAG/409



**Home Care Bag**

Item Code: BAG/408



**Pedicure Bag**

Item Code: BAG/Q040606



**Paper Packet Small**

Item Code: BAG/410/SP



**Retail Paper Bag**

Large | Item Code: BAG/410/LP  
Small Gift Bag | Item Code: BAG/410/GP



# PROMOTIONAL MATERIAL



**EVO Brochure**

Item Code: PRO/E/BROCHURE



**Spa Brochure**

Item Code: PRO/1631



**Brand Brochure**

Item Code: PRO/1601/BR



**BIOGEL Brochure**

Item Code: PRO/1601/BIO



**BI-OLYGEL Brochure**

Item Code: PRO/1601/BO



**Full Cover Tip Brochure**

Item Code: PRO/1616

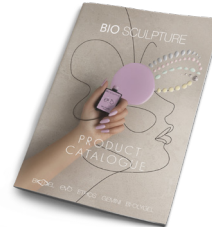

**Catalogue**

Item Code: PRO/1606



**Decal Bio Sculpture**

400 x 42mm

Item Code: PRO/1621

Reversed | Item Code: PRO/1621/R



**Gift Voucher**

Item Code: PRO/1608



**Small Logo Sticker**

100 x 11mm

Item Code: PRO/1622

Reversed | Item Code: PRO/1622/R



**Technician Badge**

Item Code: PRO/1614



**BIOGEL & EVO Colour Booklet**

Item Code: PRO/1605



**Thank You Card**

Item Code: PRO/1603



**A3 Poster**

Item Code: PRO/1627



**Client Card**

Item Code: PRO/1609



**Photo Sheet**

A4 | Item Code: PRO/PHOTOPAD

# BIO SCULPTURE

